

C-RED 3

Very High Speed and Compact SWIR Camera

Key Specifications

- ✓ 640 x 512 TECless InGaAs sensor
- ✓ 15 μm pixel pitch
- ✓ SWIR 0.9 - 1.7 μm
- ✓ 70% QE, wavelength from 0.9 to 1.7 μm
- ✓ Up to 600 fps full frame
- ✓ < 40 e- readout noise
- ✓ Adaptive bias

Key Applications

- ✓ Adaptive optics
- ✓ Laser beam profiling
- ✓ Free Space Optical Communications
- ✓ Welding
- ✓ Quality / Production control
- ✓ Unmanned aerial vehicle
- ✓ Hyperspectral Imaging



Introducing C-RED 3



Specially designed for short exposure time applications, C-RED 3 is a very compact high-speed VGA uncooled camera for short wave infrared (SWIR) imaging.

C-RED 3 uses a 640 x 512 InGaAs PIN Photodiode detector with 15 μm pixel pitch for high resolution, which embeds an electronic shutter with integration pulses shorter than 5 μs. C-RED 3 does not use a thermoelectric cooler (TECless). The cooling system has been removed to give a low size, weight and power consumption camera.

Our adaptive BIAS allows to use the camera in any variable temperature environment. Autonomous, ultra compact and also available for OEM, C-RED 3 offers a solution for every application and every budget.

Feature	Benefit
Easy integration	The camera can be easily integrated in a system thanks to the holes on the bottom, the side, or the front, and has a C-Mount/CS-Mount/T-Mount optical interface for the objective. The core version (without housing) is even easier to fit in a custom system.
High sensitivity	C-RED 3 compensates for the dark current, necessarily high for a non-regulated camera, by a very high frame rate. When used in windowing (ROI) mode at higher frame rates (up to 32066 fps), the dark current is completely negligible.
Real-time adaptive bias/dark correction	To compensate for the effects of temperature and exposure time variations on the dark frame, C-RED 3 offers an adaptive correction. Dark frames are automatically computed by the camera firmware. Calibrated in factory, this process eliminates the need to perform multiple experimental bias/dark acquisitions, hence simplifying your experiments.
Electronic shutter	C-RED 3 embeds an electronic shutter with integration pulses shorter than 5 μs in full frame mode.
Windowing and Region of Interest (ROI)	Windowing mode achieves a faster imaging rate while maintaining a very low noise, which is very interesting for FSO applications where a limited number of modes will be corrected, so a smaller amount of pixels are needed.
High frame rate	C-RED 3 can work at 600 fps in full frame mode. The frame rate increases up to several kHz in ROI mode (for example 9.5 kHz for a 64-by-64 pixels ROI).
Low camera latency	The delay between the end of integration and the first valid data on CameraLink in normal readout mode full frame is 22.2 μs (default) and can be tuned down to 7.4 μs.
Numerous synchronization mechanisms	Internal and external triggers allow optimal interface of the camera to the rest of the FSO and AO system (laser, computer, etc.).

Quality / Production Control

Imaging has long been used in industrial processes to measure, monitor, control or otherwise manage the production of goods. The challenge is to capture vivid and measurable contrast of the monitored objects' characteristics.

SWIR provides highly contrasted images that enable the differentiation of materials or the identification of defects. Additionally, SWIR cameras can see through coatings or containers that are opaque to the eye. They enable visualization of underlying features such as fill levels, anticounterfeiting security codes, or hidden moisture while using machine vision standard glass optics.

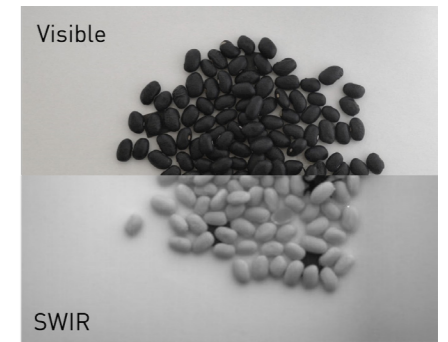

Images in the visible and SWIR (900 – 1700 nm) range of black beans polluted by a plastic fly and a few square cardboard pieces. Camera used: C-RED 3 with SWIR lens 16 mm, uncooled, non-stabilized, low gain.

Surveillance and Safety

One of the principle advantages of using SWIR technology for Safety or Surveillance applications, is the ability of SWIR cameras to “see through” smoke, haze, mist, fog and other challenging atmospheric conditions. A significant improvement of contrast compared to visible range images can be observed. Furthermore, our SWIR cameras offer high sensitivity in low light environment, allowing night vision, for example.

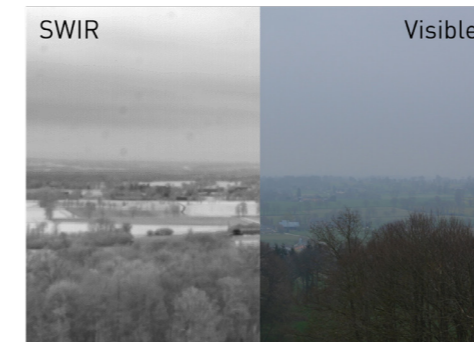

Images in the visible and SWIR (900 – 1700 nm) range of a foggy countryside view. In the SWIR range, you can see “through” the fog and see the trees a couple of hundred meters further than in the visible range. Camera used: C-RED 3 with SWIR lens 16 mm, uncooled, non-stabilized, low gain.

Laser Beam Profiling

Laser beam profiling is a technique used to measure and analyze the spatial characteristics of a laser beam. It provides information on intensity distribution, shape, and size. It has multiple applications:

- ✓ Monitoring laser quality, this can include measuring spatial intensity distribution and temporal stability.
- ✓ Laser beam profiles can be used to gain a better understanding of laser physics and adjust laser parameters for optimal beam shaping.
- ✓ Studying the temporal evolution of a beam, for example to assess the impact of environmental parameters (temperature, wind, snow, etc.) on the propagation of a laser beam.

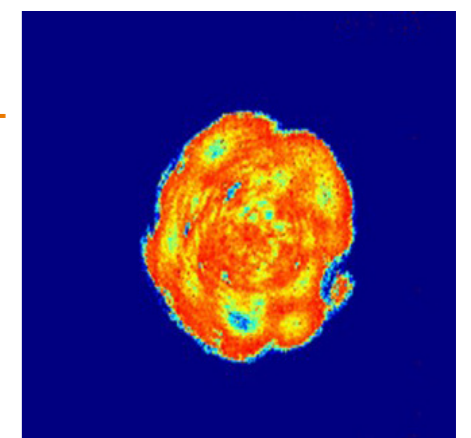

Typical top-hat laser power distribution. Acquisition with a C-RED 3 camera

Technical Specifications

Specifications^{•1}

Sensor Specifications		C-RED 3
Sensor size		640 x 512 pixels
Pixel pitch		15 μm
Maximum speed Full Frame		600 fps
Readout Noise at high gain, Tint at 50 μs, 600 fps Full Frame		< 40 e-
Dark Current @ - 40°C		< 600 e/p/s
Quantization		14 bit
Flat Quantum Efficiency 1.0 to 1.65 μm		> 70%
Operability due to signal response (pixels with signal ± 0.3' median at 20°C)		> 99.5%
Image Full well capacity	low gain	1400 ke-
	med gain	128 ke-
	high gain	33 ke-
Maximum speed in 32 x 4 (min)		32066 fps
Maximum speed in 320 x 256		1779 fps

Additional Features		C-RED 3
Output		USB 3.1 Gen 1 or CameraLink®
Optical interface		C-Mount, CS-Mount, T-Mount
Triggering		LVTTTL Synchronization (5 V tolerant)
HDR mode		93 dB and 16 bits
Firmware feature		Adaptive bias
Cooling		Operating temperature -40°C to 35°C Liquid cooling optional with cooling plate for optimized performances
Software		Graphical User Interface: First Light Vision Software Development Kit: (C, C++, C#, Python, MatLab) / LabVIEW / μManager

Lines	Frame rate at 600 fps readout speed CameraLink® Output						
	Columns						
	32	64	128	256	512	640	
4	32066	31512	30458	28548	25367	24029	
8	28108	27348	25945	23532	19840	18397	
16	22542	21631	20015	17413	13819	12526	
32	16147	15254	13736	11455	8599	7646	
64	10302	9596	8440	6801	4898	4297	
128	5975	5509	4765	3752	2632	2291	
256	3247	2975	2547	1978	1367	1184	
512	1697	1549	1319	1016	697	602	

For USB 3 Output: Max 9999 FPS

Product Drawings

Dimensions in mm (inches)
Weight: 230 g

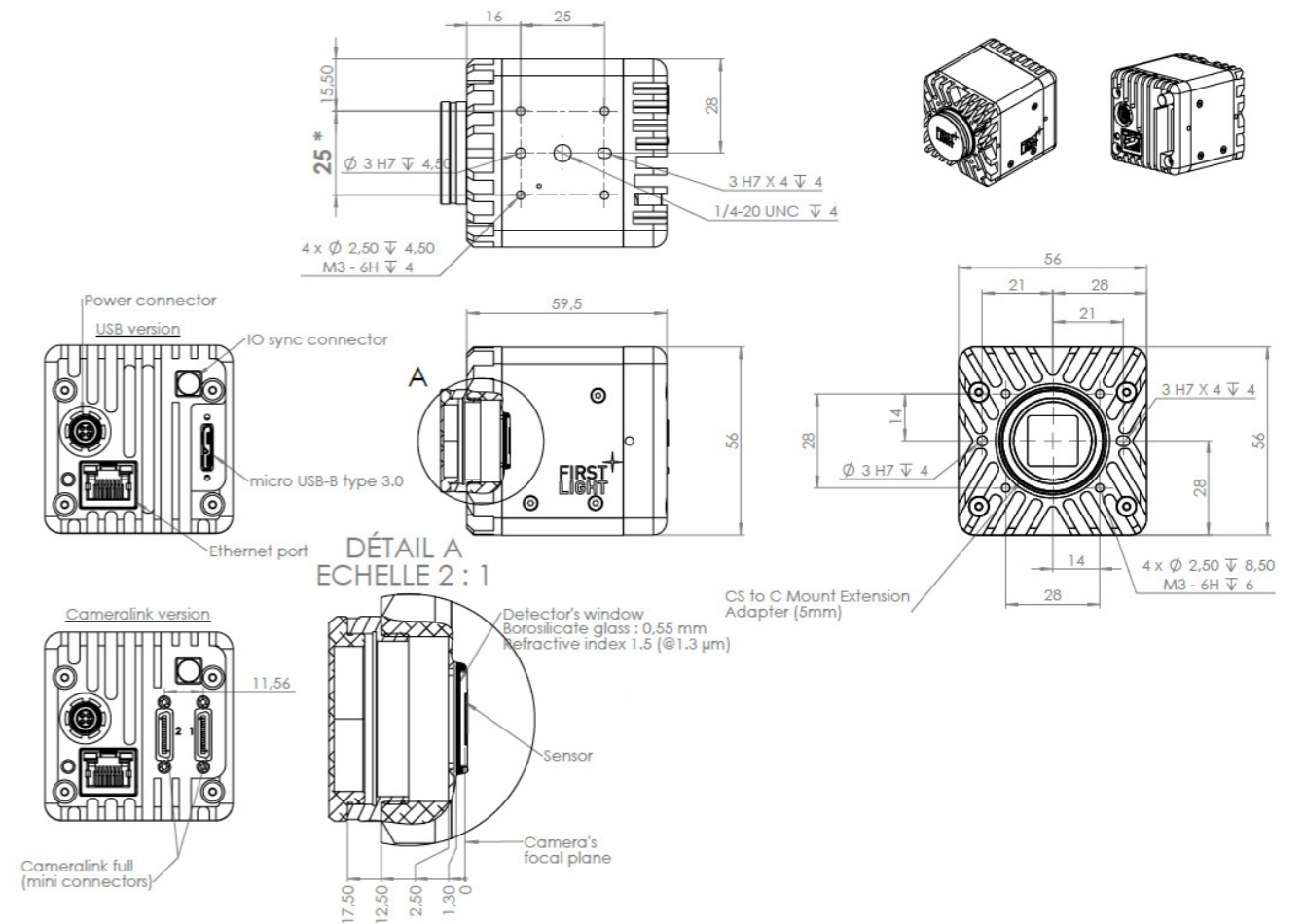

Quantum Efficiency (QE) Curve

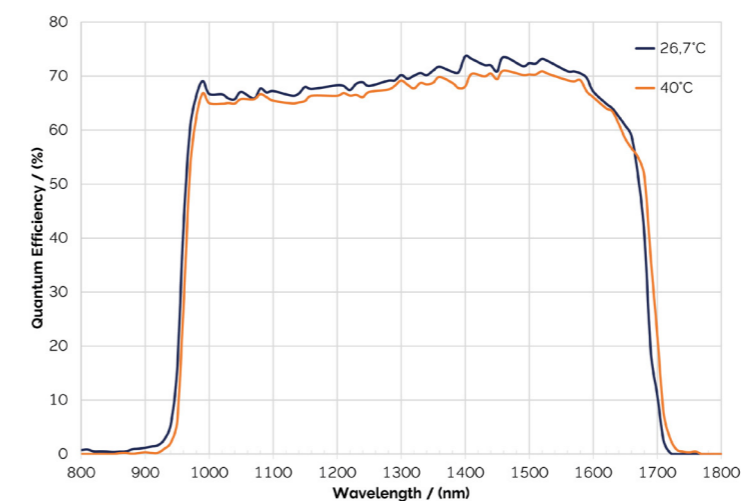

OEM Module Available

Specially designed C-RED-3 OEM version without housing, and custom features for easy integration in larger systems. It has been designed for low SWaP with 55x55x60 mm³ dimensions, 230 g in standard version and 100 g in OEM version. The camera offers extensive customization in hardware, electronic design and firmware to ensure optimal performance.

Contact our team to discuss your project requirements.

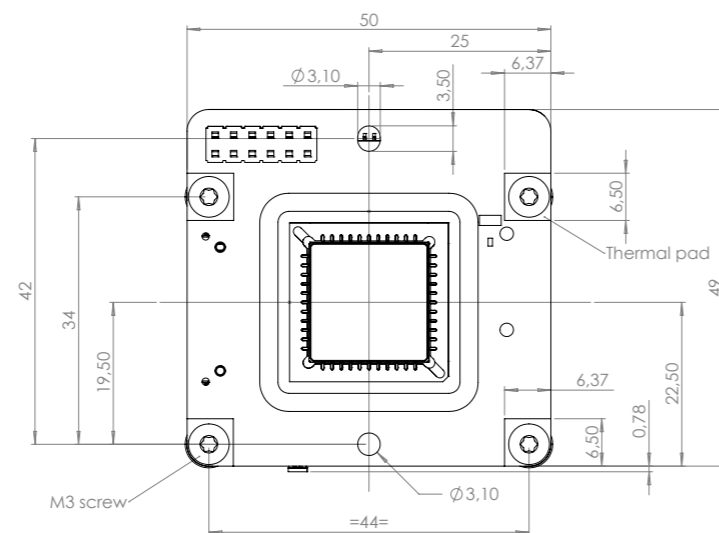
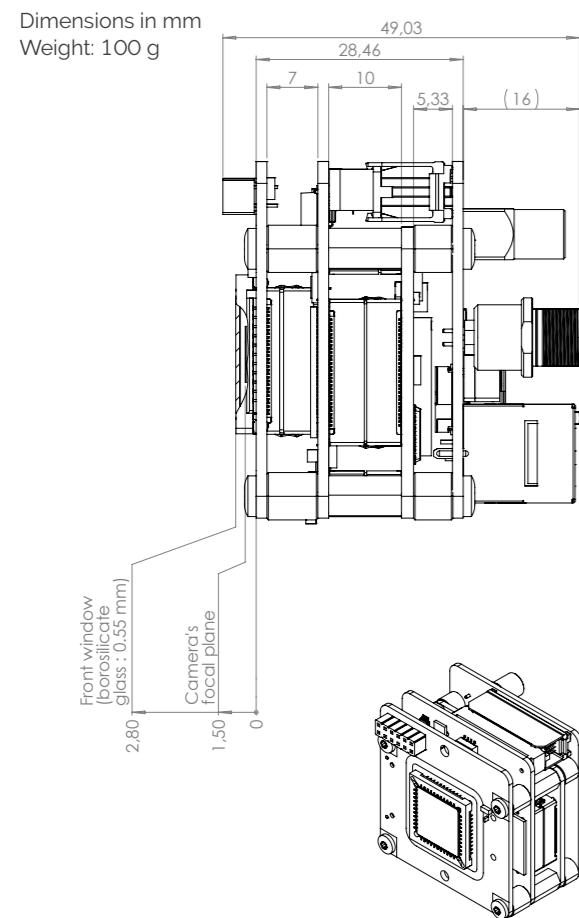
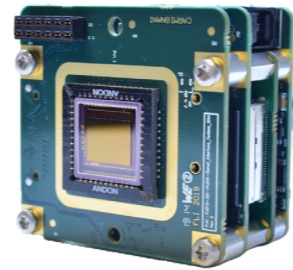

Creating The Optimum Product for You

Step 1. Select the camera type

Camera Type



Description	Code
C-RED 3 CL: 640 x 512 InGaAs TECless camera, 600 fps, <40 e- RON, Camera Link® interface	PAC-CR3-CLF-SSU
C-RED 3 USB: 640 x 512 InGaAs TECless camera, 600 fps, <40 e- RON, USB3 interface	PAC-CR3-USB-SSU

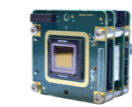

Description	Code
C-RED 3 CL camera core: 640 x 512 InGaAs TECless board level, 600 fps, <40 e- RON, Camera Link® interface	PAC-CR3-CLF-SSU-C
C-RED 3 USB camera core: 640 x 512 InGaAs TECless board level, 600 fps, <40 e- RON, USB3 interface	PAC-CR3-USB-SSU-C

Step 2. Select the required accessories

Accessories

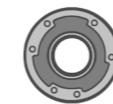

Description	Order Code
Cooling pack	PAC-COO-200-000
Hydraulic cooling plate	ACC-HYD-CR3-000
Quick coupling set	ACC-QCS-CAM-001
Synchro cables 1 m	ACC-CAB-SYN-000
Synchro cables 3 m	ACC-CAB-SYN-001
Camera Link® cables 5 m	ACC-CAB-CLF-000
Camera Link® cables 10 m	ACC-CAB-CLF-001
Matrox Grabber CL RAD EV 1G CLSF	ACC-GRA-CLF-000

Step 3. Software



Software

Your product is provided with the following software options:
 Graphical User Interface: First Light Vision
 Software Development Kit: (C, C++, C#, Python, MatLab) / LabVIEW / µManager

Order Today

Need more information? At Andor we are committed to finding the correct solution for you. With a dedicated team of technical advisors, we are able to offer you one-to-one guidance and technical support on all Andor products.

For a full listing of our local sales offices, please see: andor.oxinst.com/contact

Our regional headquarters are:

Europe

Belfast, Northern Ireland
Phone +44 (28) 9023 7126
Fax +44 (28) 9031 0792

North America

Concord, MA, USA
Phone +1 (860) 290 9211
Fax +1 (860) 290 9566

Japan

Tokyo
Phone +81 (3) 6744 4703
Fax +81 (3) 3446 8320

China

Beijing | Shanghai | Guangzhou
Phone +86 (400) 678 0609
Fax +86 (10) 5884 7901



Items shipped with your camera:

- 1x Camera (model as ordered)
- 1x Power supply
- 1x Power supply cable
- 1x USB cable (if USB interface)
- 1x C-Mount adaptor
- 1x Quick start guide

Minimum Computer Requirements:

- RAM: 8 GB minimum
- Processor: Intel® Core™ i5 or higher
- Screen resolution: at least 1920 x 1080
- See [system requirements](#) for more information.

Operating and Storage Conditions

- Operating Temperature: -40°C to 35°C
- Relative Humidity: < 95% (non-condensing)
- Storage Temperature: -40°C to 60°C

Power Requirements

- 100 - 240 VAC 50 - 60 Hz
- Max. power consumption: 18 W

Footnotes: Specifications are subject to change without notice

1. Average values observed.